

KOBLOCH

Basic



Vægmonteret postkasseanlæg

Knobloch GmbH har fremstillet postkasser og postkasseanlæg, siden firmaet blev grundlagt i 1896, og er i dag en af Europas førende fabrikanter.

Knobloch-Basic er en serie vægmonteret postkasseanlæg udelukkende til indendørs montering.

Basic serien er prisvenlig løsning, som dækker de mest almindelige behov til en ejendom.

Alle Basic anlæg er godkendt iht. DS/EN 13724

DS/EN 13 724



Alle anlæg håndbygges på bestilling

Indhold:

Side:

Brevkasse typer	02
HA3711-27	03
HA3717-27	04
VA3733-16	05
Skråtag	06
Låse	06
Brevklap-lås	07
Etagegravering	07
Farver	08
Pulverlakering	08
Specifikation	09
Reservedele	09
Levering	10

Typer:

Et Basic anlæg opbygges af enten vandretliggende kasser (Type **HA**) eller opretstående kasser (Type **VA**).

Type HA

Vandretliggende kasser

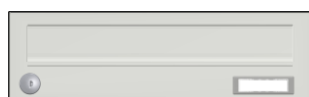
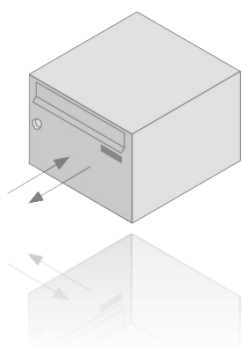
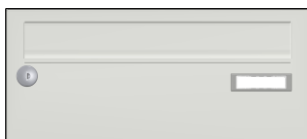
**HA3711-27****HA3717-27****Type VA**

Opretstående kasser

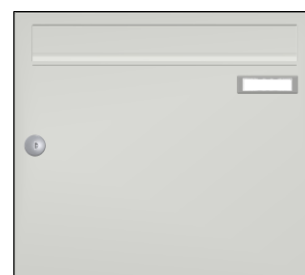
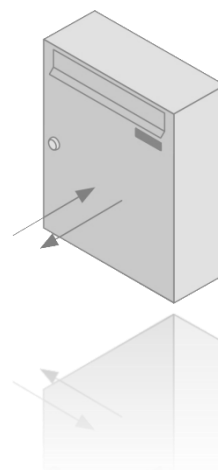
**VA3733-16**

Model: **HA3711-27**

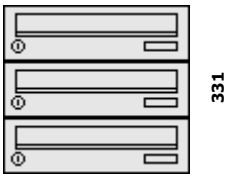
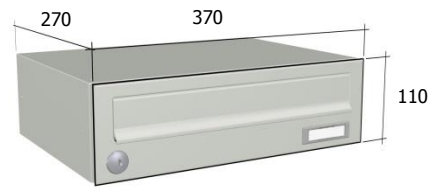

331

B3711.27.103

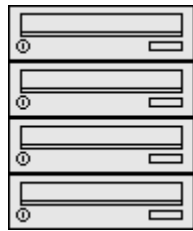

442

B3711.27.104

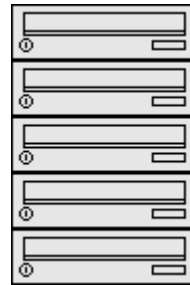

552

B3711.27.105

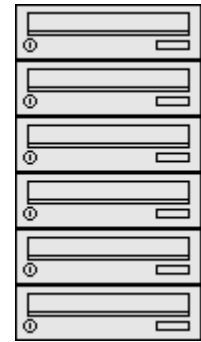

663

B3711.27.106

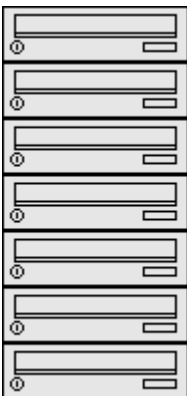

773

B3711.27.107

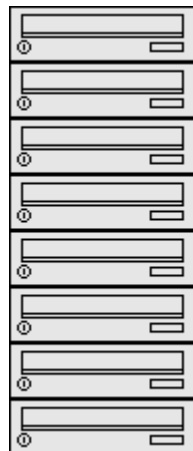

884

B3711.27.108

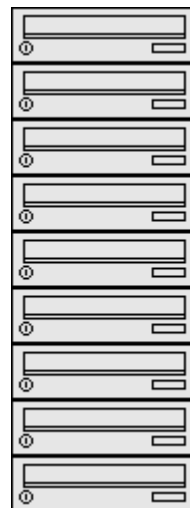

994

B3711.27.109

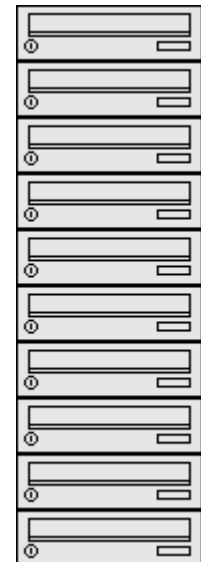

1105

B3711.27.110

Model: **HA3717-27**

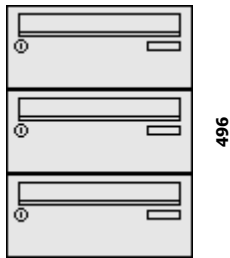

496

B3717.27.103

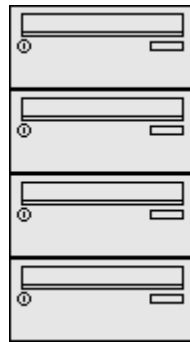

662

B3717.27.104

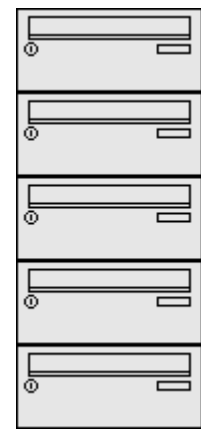

827

B3717.27.105

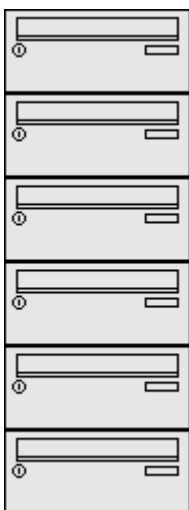

993

B3717.27.106

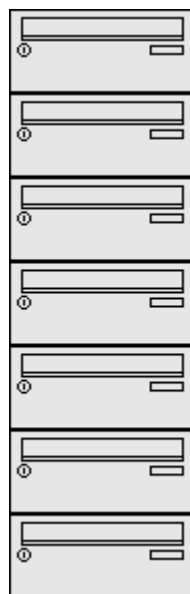

1158

B3717.27.107

Model: **VA3733-16**

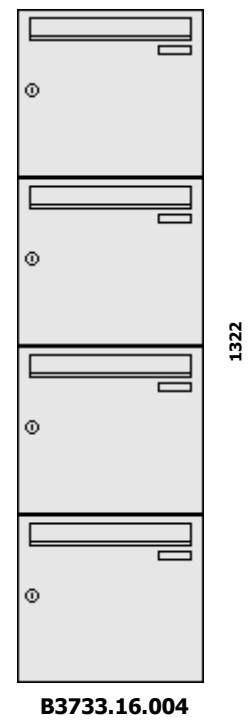
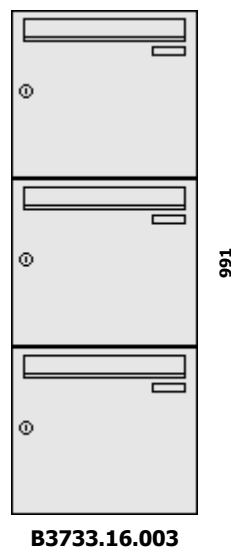
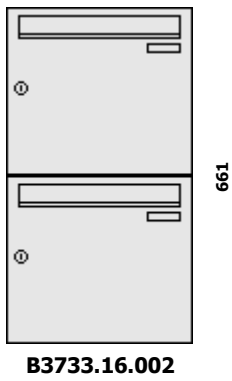
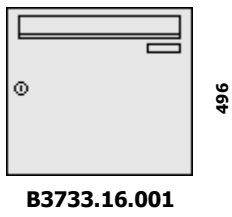

Skråtag:

Alle Basic anlæg kan leveres med skråtag, som er monteret fra fabrikken. Skråtaget anvendes for at undgå, at reklamer, aviser o.a. bliver lagt på toppen af anlægget.

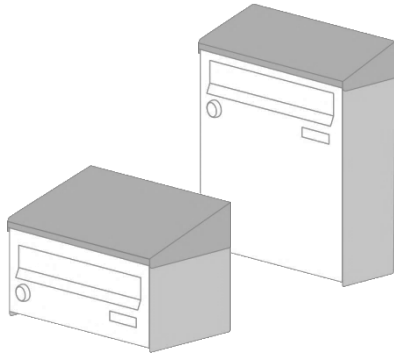

Låse:

Basic kan leveres enten med:

1:
6 stift cylinderlås inkl. 3 nøgler.

2:
Hul til systemlås, hvis man allerede har et låsesystem i boligen.

1:



2:



Brevklap-lås:

En brevklap-lås er en praktisk og synlig lås, som kan anvendes i tilfælde af, at en bolig er midlertidig ubeboet eller under renovation.

Normalt må man ikke aflåse sin brevklap med undtagelse af d. 31/12. Det vil sige, hvis man f.eks. er på ferie, må man lave en aftale med sin nabo om at tømme postkassen, mens man er væk.

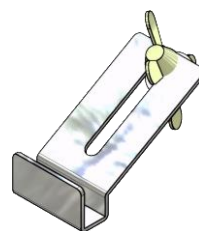

Vare nr.: **10.549**

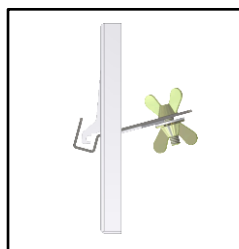
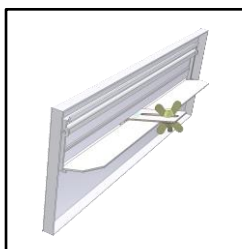
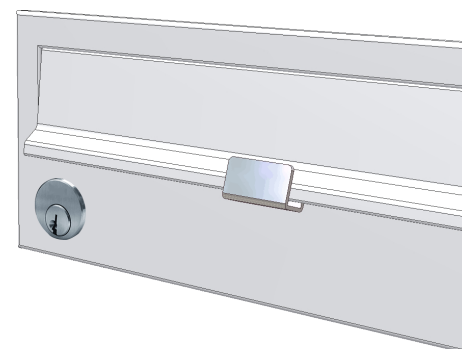

Brevklap-låsen fastgøres på lågens tyverifang og kan kun monteres, når lågen er åben.



Etagegraving:

I henhold til lovgivningen skal den enkelte brevkasse i et anlæg være forsynet med etageangivelse og evt. lejlighedsnummer.

Etagegraving i brevklappen er den perfekte løsning.

Knobloch graverer etagenummer i brevklappen, så det ikke kan ridses eller skræbes af.

Etage nr. nedfræses i brevklappen og farves efterfølgende med hvid eller sort bundfarve.

Bundfarven er sort eller hvid afhængig af, om anlægget er lyst eller mørkt.

1. TH

1. TH

Farver:

Knobloch-Basic anlæg kan leveres i 7 forskellige standard farver.

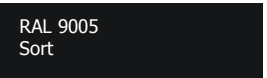
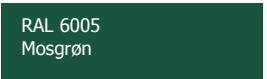
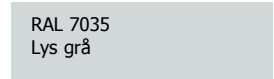
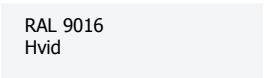
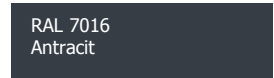
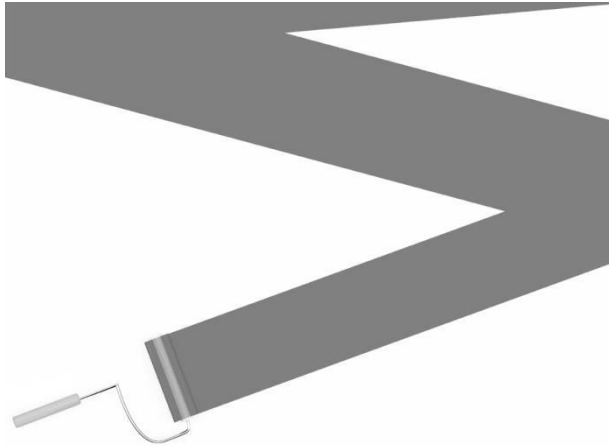

Et anlæg kan bestilles ensfarvet eller f.eks. med mørke brevkasser og lys brevklap.

Pulverlakering:

Alle anlæg er pulverlakerede med minimum 70My både indvendig og udvendig og brændt ved 200° C, hvilket giver en ekstra beskyttelse samt ensartet og glat overflade.



Specifikationer:

Materialer:

- Brevkasser: Elforzinket stål.
- Låger: Elforzinket stål
- Brevklap: Aluminium C4
- Hængsler: Rustfrit stål med messing tap.

Finish:

- Brevkasser, låger og brevklap er pulverlakeret i ovennævnte farver.

Udstyr:

- Brevklapper er forsynet med en gummiliste, der dæmper lyden, når den lukker.
- Lågerne har tyverisikring, så posten ikke kan fiskes ud af brevkassen.
- Alle låger er forsynet med navneskilt i kunststof med skrivefelt.

Låse:

- Basic kan leveres med hul til systemlåse eller
- Med 6 stift cylinderlås inkl. 3 nøgler.

Tilbehør:

- Skråtag vælges til efter ønske.
- Etagegravering vælges til efter ønske.

Garanti

- 5 års produktgaranti
- 10 års garanti mod gennemtæring
- 20 års reservedels garanti

Reservedele:

Følgende dele kan udskiftes

- Brevklap
- Låse
- Låge
- Navneskilt
- Hængsler

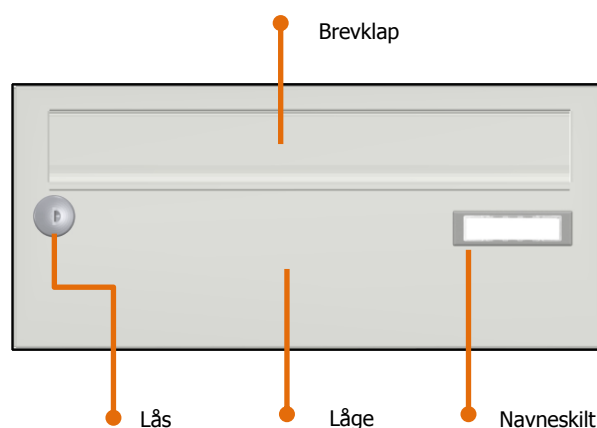

Hængsler

Levering:

Alle anlæg leveres direkte fra Knobloch i Tyskland til ønskede adresse i Danmark.





Knobloch - Danmark
Tel: 24231524
info@max-knobloch.dk
www.max-knobloch.dk